

Name : _____ ()

Class : Primary 5 _____

CHIJ ST NICHOLAS GIRLS' SCHOOL



Primary 5

End Year Assessment 2022

SCIENCE

BOOKLET A

31 October 2022

Total Time for Booklets A and B: 1 hour 45 minutes

28 questions

56 marks

**Do not open this booklet until you are told to do so.
Follow all instructions carefully.**

This paper consists of 19 printed pages.

Section A (28 x 2 marks = 56 marks)

For each question from 1 to 28, four options are given. One of them is the correct answer. Make your choice (1, 2, 3 or 4). Shade the correct oval (1, 2, 3 or 4) on the Optical Answer Sheet provided.

1. Which of the following correctly shows the similarity and difference between the bread mould and the fern?

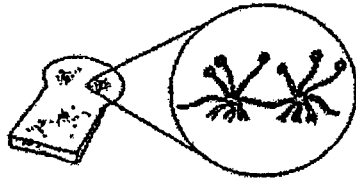

bread mould

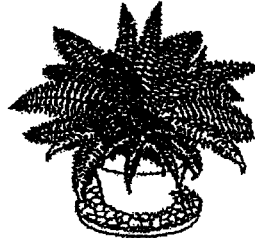

fern

	Similarity	Difference
(1)	Both are microorganisms.	The bread mould produces spores but the fern produces seeds.
(2)	Both can make their own food.	The bread mould does not have leaves but the fern has leaves.
(3)	Both respond to changes.	The bread mould is a fungi but the fern is a plant.
(4)	Both reproduce by spores.	The bread mould cannot make its own food but the fern can make its own food.

2. Which of the following is a function of the human skeletal system?

- (1) protects organs in the body
- (2) protects the muscular system
- (3) transports blood around the body
- (4) transports food in the digestive system

3. Which one of the following organisms is not a fungus?

- (1) fern
- (2) yeast
- (3) mould
- (4) mushroom

4. Study the flow chart below.

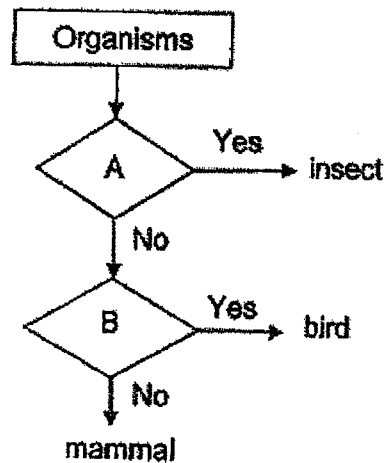

Which of the following shows the characteristics represented by A and B?

Characteristics	
A	B
(1) has fur	has beak
(2) has six legs	has feathers
(3) has wings	has fur
(4) has hard body covering	gives birth to young

5. Which of the following characteristic(s) is/are found in birds, but not in other animals?

- A They lay eggs.
- B They have wings.
- C They have a streamlined body.
- D They have feathers on their bodies.

- B only
- (2) D only
- (3) A, B and D only
- (4) A, B, C and D

6. The diagram below shows the life cycle of a living thing.

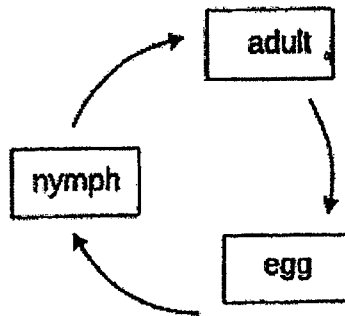

Which one of the following is likely to have a similar life cycle?

- (1) Frog
- (2) Chicken
- (3) Butterfly
- (4) Dragonfly

7. Which one of the following shows the correct sequence of the life cycle of a flowering plant?

- A A fruit forms.
- B A seed germinates.
- C The plant bears flowers.
- D A seedling becomes an adult plant.
- E The petals wither.

- (1) A → D → E → B → C
- (2) B → D → C → E → A
- (3) C → A → D → B → E
- (4) D → A → B → C → E

8. The diagram below shows insect A on the stem of a plant. It feeds on food made by the leaves. Two cuts X and Y were made on the stem of the plant.

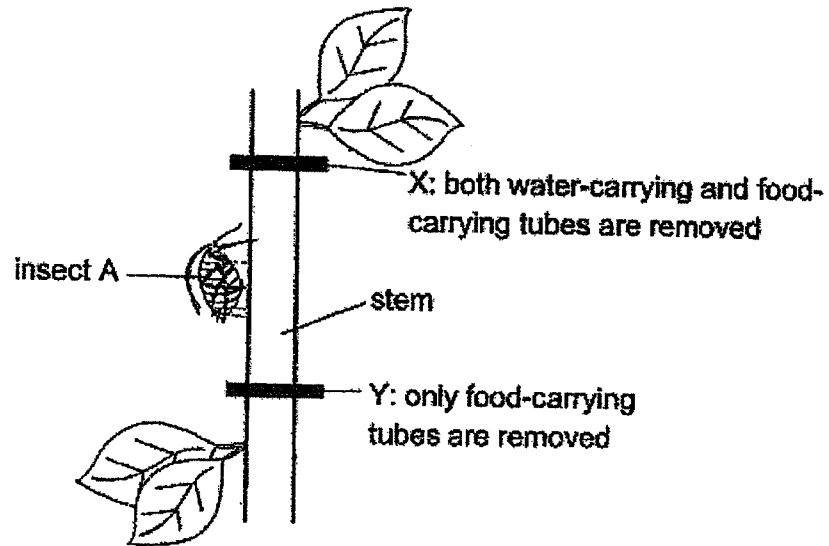

Which of the following statements about insect A is true?

	Can insect A feed on food made by the leaves?	Explanation
(1)	No	Food made by the leaves above X cannot be transported upwards.
(2)	No	Food made leaves above X cannot be transported
(3)	Yes	Food is found in water-carrying tube above Y.
(4)	Yes	Food made by leaves below Y is transported upwards.

9. Ms Tan was making a cup of coffee using a filter bag as shown below. She poured hot water into the filter bag and the bag prevents the coffee powder from getting into the cup.

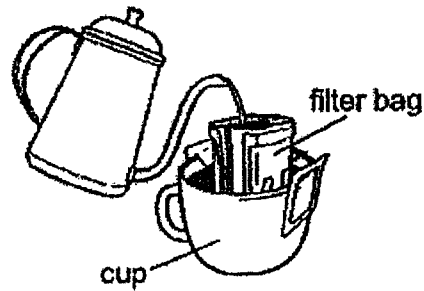

Which part of a cell has a similar function as

- (1) Nucleus
- (2) Cell wall
- (3) Cytoplasm
- (4) Cell membrane

10. Study the diagrams of the three different types of cells shown below.

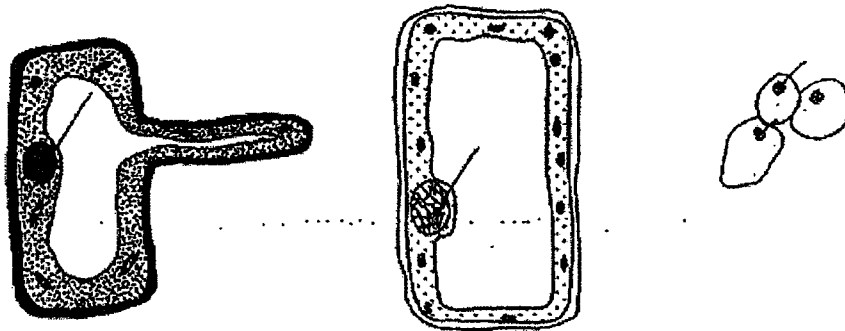

Which of the following parts are present in all the three types of cells?

- (1) Nucleus, cytoplasm and cell wall
- (2) Nucleus, chloroplast and cytoplasm
- (3) Nucleus, cell membrane and cytoplasm
- (4) Nucleus, cell wall, cell membrane and cytoplasm

11. The graph below shows the amount of nitrogen, oxygen and carbon dioxide in the air that we breathe in.

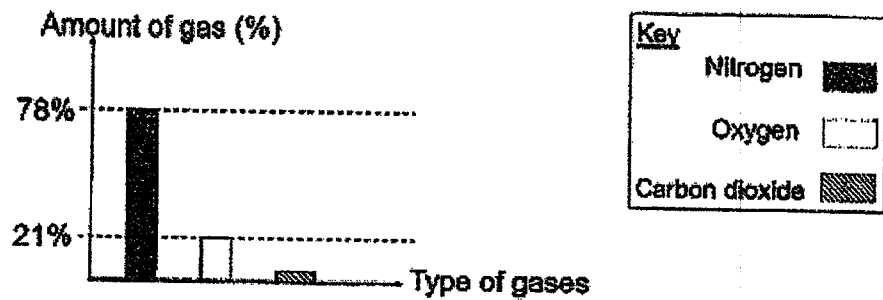

Which of the following graphs most likely shows the amount of these gases in the air that we breathe out?

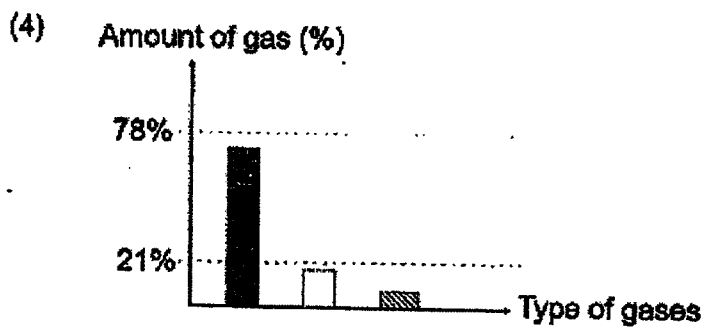
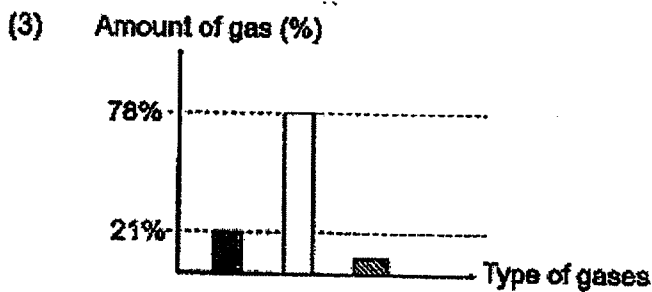
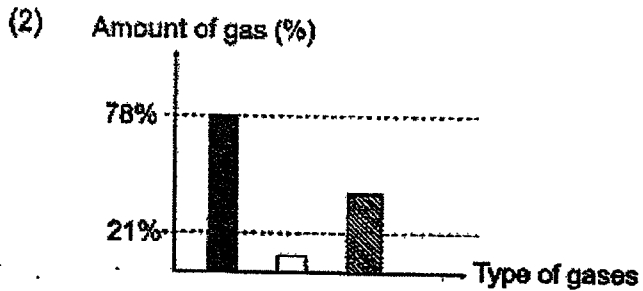
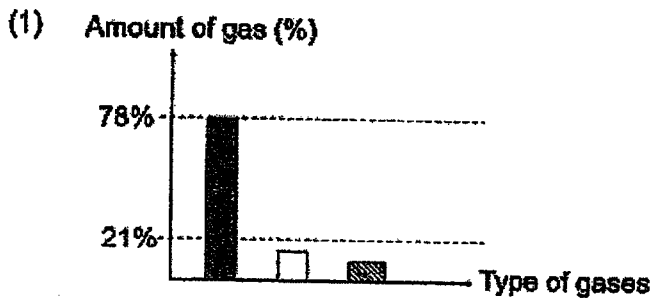

12. The diagram below shows three human body systems.

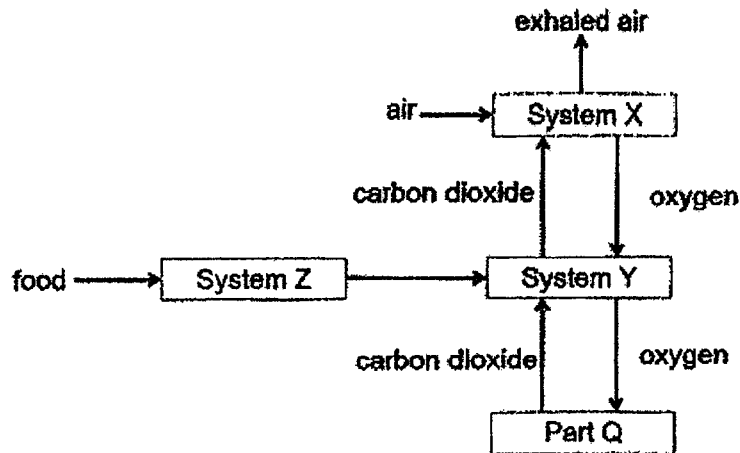

Which of the following correctly shows Systems X, Y, Z and Part Q?

	System X	System Y	System Z	Part Q
	Circulatory	Digestive	Respiratory	Legs
(2)	Respiratory	Digestive	Circulatory	Heart
	Circulatory	Respiratory	Digestive	Lungs
(4)	Respiratory	Circulatory	Digestive	Head

13. The flow chart below shows the reproduction process in flowering plants.

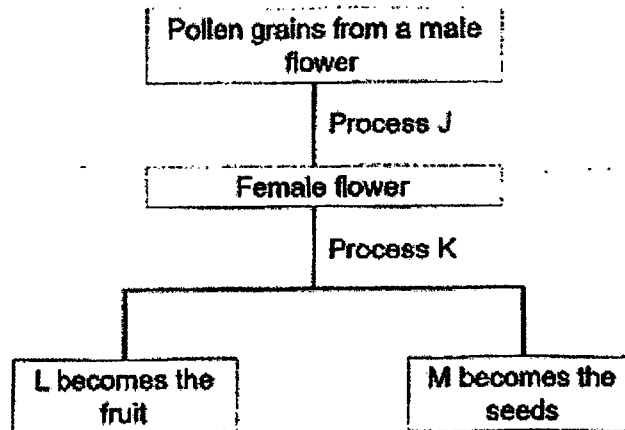

Which of the following correctly represents J, K, L and M?

	Process		Part of the flower	
	J	K	L	M
	pollination	germination	ovules	ovary
	fertilisation	pollination	ovules	ovary
	germination	fertilisation	ovary	ovules
(4)	pollination	fertilisation	ovary	ovules

14. The flowers below show some parts of it being removed.

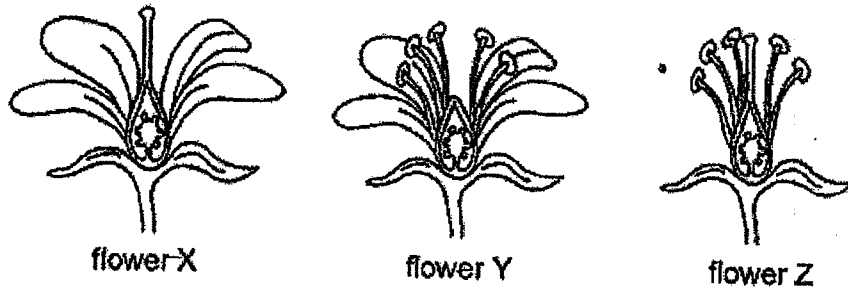

Which flower(s) will not be able to become a fruit?

- (1) Flower Y only
 - (2) Flowers X and Y only
 - (3) Flowers Y and Z only
 - (4) None of the flowers
15. Susan wanted to find out how the length of the wing-like structure of a fruit affects the distance it is dispersed.

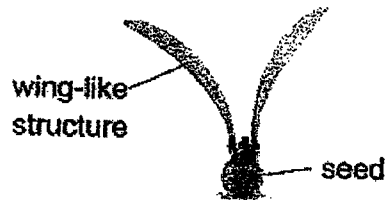

She prepared four set-ups as described in the table below.

Set-up	Length of wing (cm)	Mass of seed (g)	Presence of wind
A	5	9	Yes
B	5	9	No
C	10	9	Yes
D	10	12	Yes

Which pair of set-ups should Susan use to conduct a fair test?

- (1) A and B
- (2) B and C
- (3) A and C
- (4) C and D

16. The table below shows the boiling and melting points of three substances X, Y and Z.

Substances	X	Y	Z
Boiling Point (°C)	25	185	70
Melting Point (°C)	0	29	12

Which one of the following shows the states of the substances X, Y and Z at room temperature of 28 °C?

(3)

X	Y	Z
liquid	solid	gas
gas	liquid	solid
gas	solid	liquid
solid	gas	liquid

17. Four different containers A, B, C and D were left at the same place. Each container contained 100 cm³ of water at the same temperature. At every hour, the volume of water in each container was measured and recorded. The graph below shows how the volume of water in the container changed over six hours.

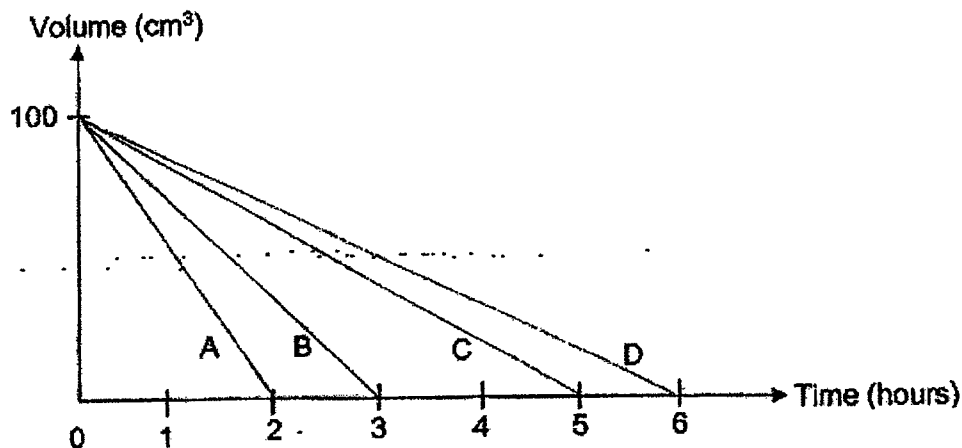



Based on the graph, which statement is correct?

- (1) Water in D has a larger exposed surface area than water in A.
- (2) Water in C has a larger exposed surface area than water in B.
- (3) Water in B has a smaller exposed surface area than water in D.
- (4) Water in C has a smaller exposed surface area than water in A.

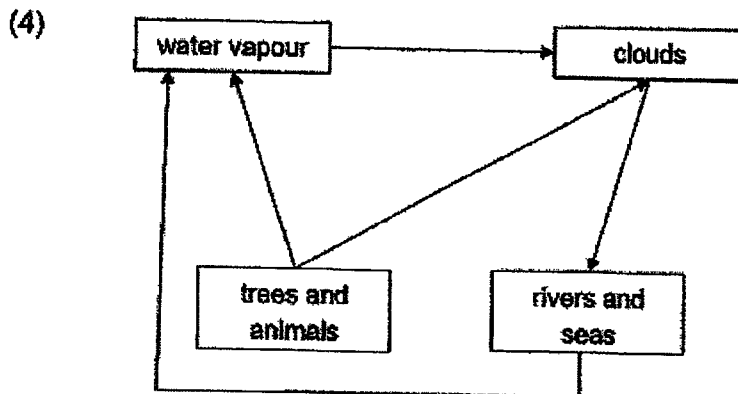
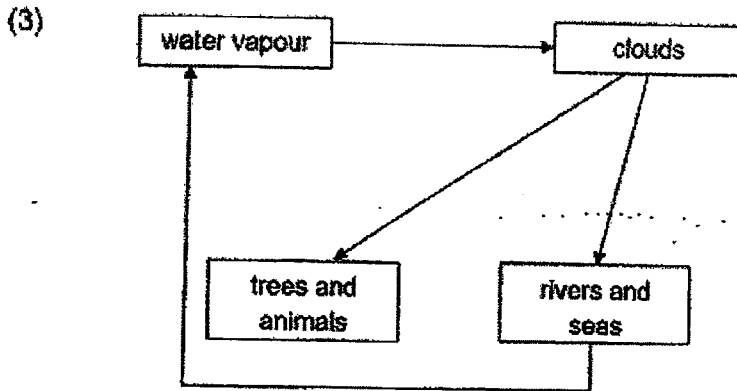
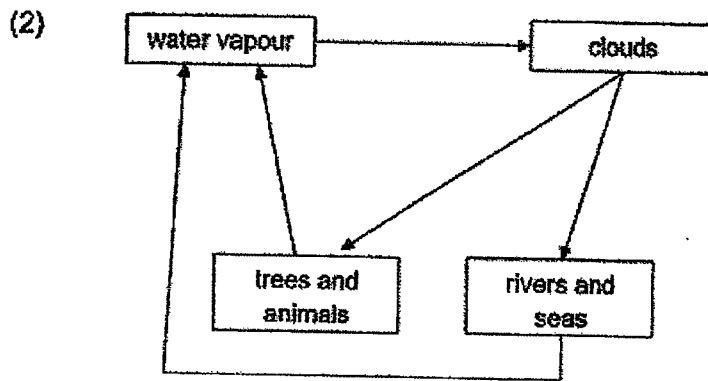
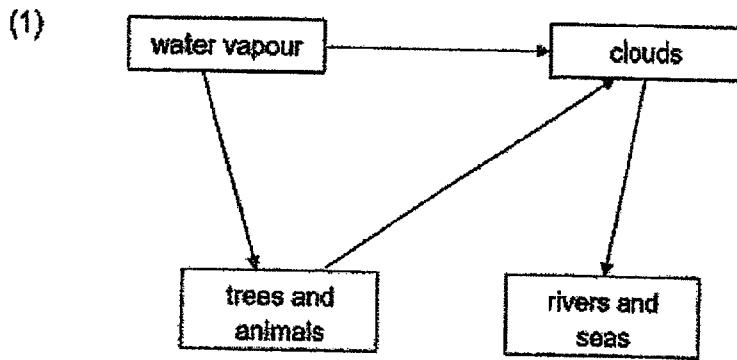
18. Which of the following diagrams correctly shows how trees and animals play a part in the water cycle?



19. Koon Seng measured the volume and mass of 3 balls that are made of different materials. He recorded the results in the table below.

Ball	Volume	Mass
A 	50 cm ³	500 g
B 	150 cm ³	300 g
C 	200 cm ³	300 g

Based on the information given, which one of the following conclusions _____

- (1) Balls of different sizes can have the same mass.
- (2) A smaller ball occupies less space than a bigger object.
- (3) Balls of different sizes occupy different amount of space.
- (4) A ball that occupies less space is lighter than an object that occupies more space.

20. Bala used the set-up below to open the tight metal lid of a glass jar.

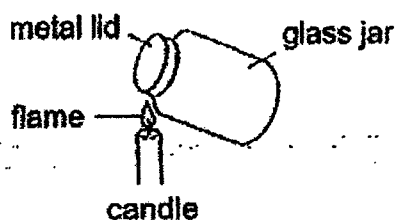

Why was he able to open the _____ more easily after heating it for some time?

- (1) The glass jar contracted.
- (2) The metal lid and the glass jar expanded.
- (3) The metal lid expanded more than the glass jar.
- (4) The air in the glass jar expanded and pushed the metal lid open.

21. Some tests were conducted before deciding on suitable material for making part K of the safety helmet worn by cyclists as shown below. is to protect the cyclist's head when he falls.

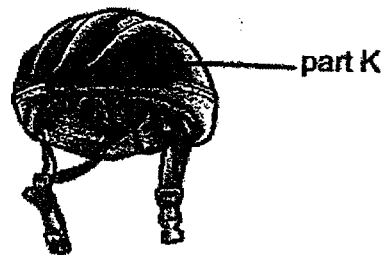

The questions asked during the tests are recorded in the table below.

Test	Question
A	Is the material light?
B	Is the material strong?
C	Is the material waterproof?
D	Is the material transparent?

Which tests are the most important in deciding the most suitable material in making part K of the safety helmet?

- (1) A and B only
- (2) C and D only
- (3) A, B and C only
- (4) B, C and D only

22. The diagram shows three objects of different shapes and made of different materials.

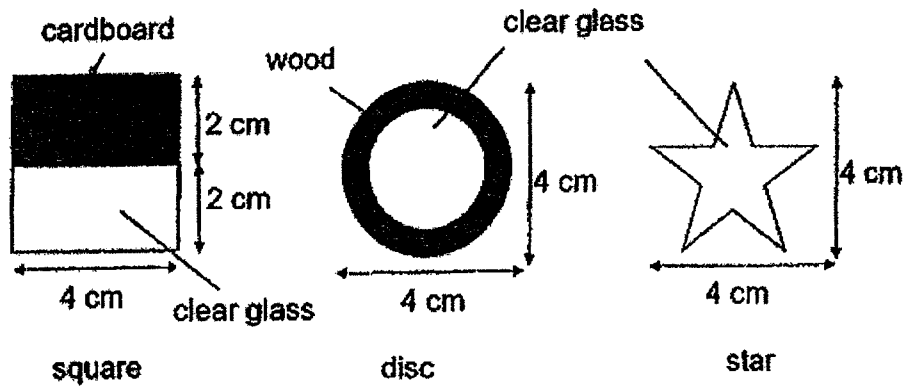

The three objects were glued together. They were placed between a torch and a screen as shown below.

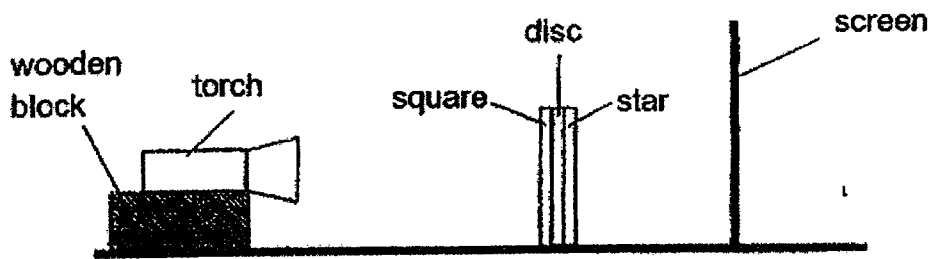

Which of the following shows the correct shadow on the screen?

(1)



(2)



(3)



(4)



23. Alan placed a box under a ceiling light as shown below. The box was moved randomly to three different positions S, T and U and the length of the shadow formed on the ground was measured.

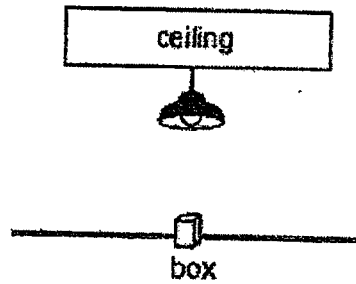

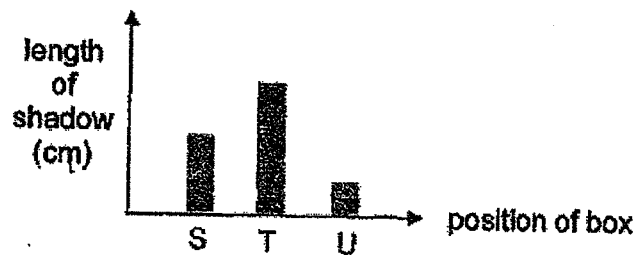

He recorded the results in the graph shown below.

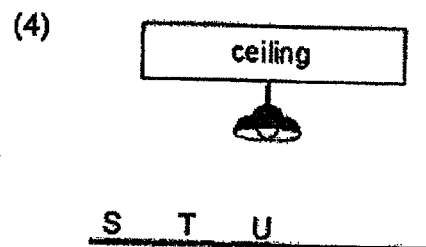
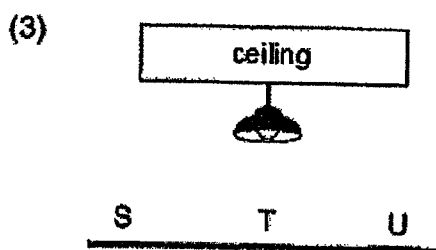
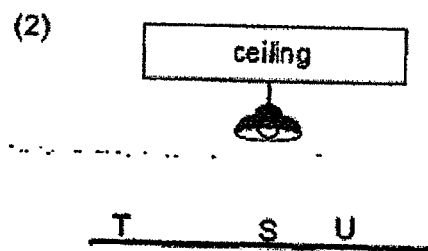
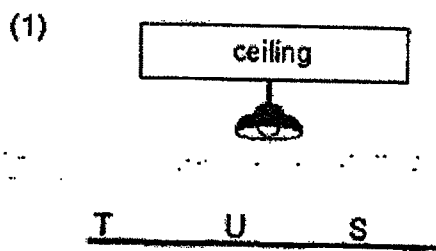

Which of the following shows the correct positions of the box?

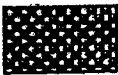

24. The table below shows the length of three metals when heated to 100 °C.

Key	Metal	Length of metal at room temperature (mm)	Length of metal at 100 °C (mm)
	P	100	111
	Q	100	102
	R	100	106

Metals P, Q and R were used to make rings as below. The rings were immersed in cold water °C for 10 minutes.

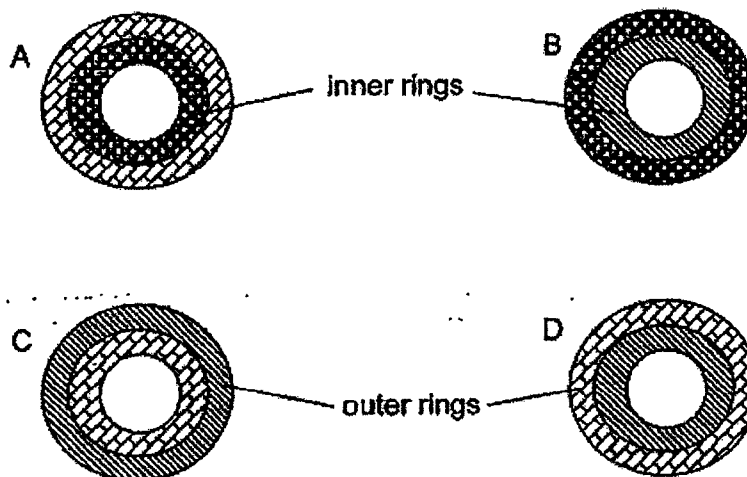

Which of the inner rings could be easily removed at the end of 10 minutes?

- (1) A only
- (2) A and C only
- (3) B and D only
- (4) C and D only

25. Five bar magnets are placed together as shown in the diagram below.

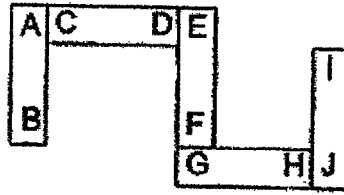

Which of the following arrangements is possible when three of the bar magnets from the above set-up are brought close together?

(1)



(2)

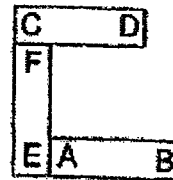

(3)

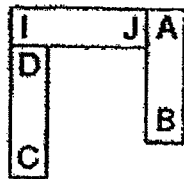

(4)

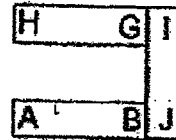

26. Ron set up two circuits X and Y as shown below. In each circuit, there is a plastic rod, a glass rod and a copper rod.

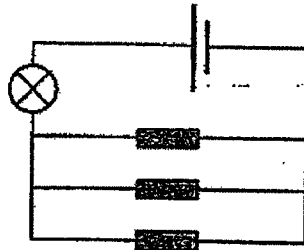

Circuit X

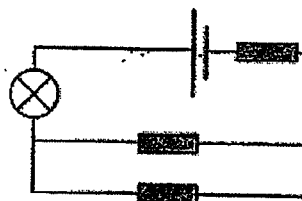

Circuit Y

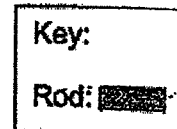

In which circuit(s) will the bulb light up?

- (1) Circuit X only
- (2) Circuit Y only
- (3) Circuit X and Y
- (4) None of the circuits

27. Hassan tested 4 rods of different materials R, S, T and U. He placed a magnet near the two ends of each rod and recorded his observations in the table below.

Material	Left end of the rod	Right end of the rod
R	attracted	attracted
S	attracted	attracted
T	not attracted	not attracted
U	attracted	repelled

Which one of the following classification charts below reflects the results of Hassan's tests?

(1)

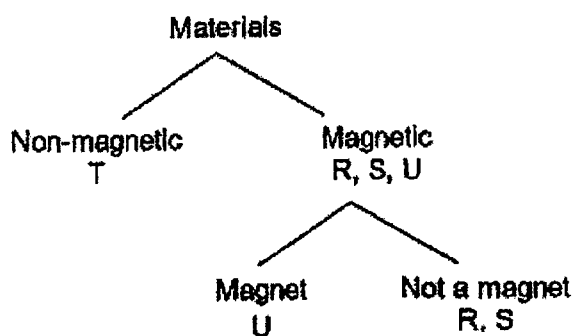

(2)

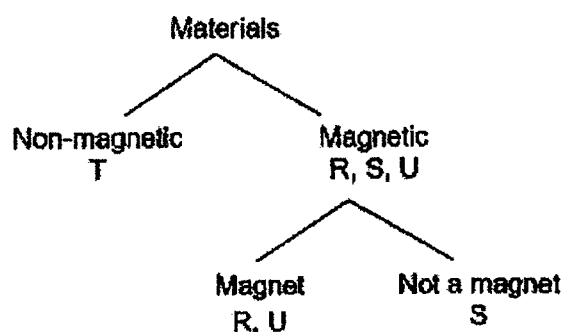

(3)

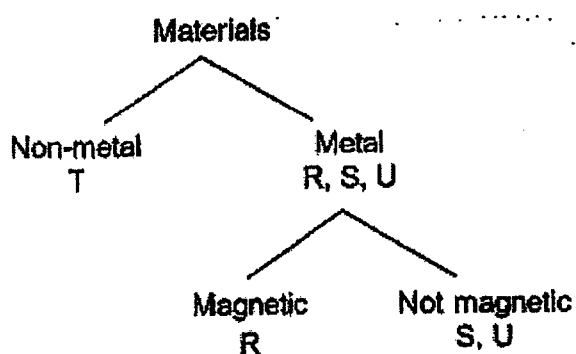

(4)

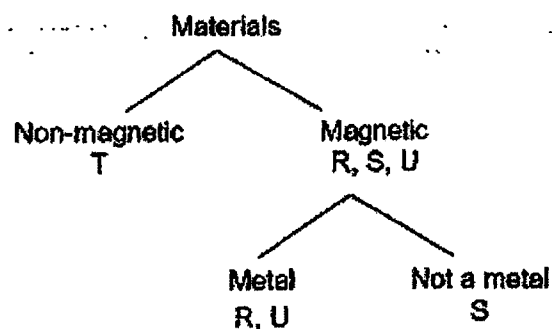

28. The diagram shows a circuit tester and the top view of a circuit card with four steel clips, W, X, Y and Z. The steel clips are connected with wires on the underside of the circuit card.

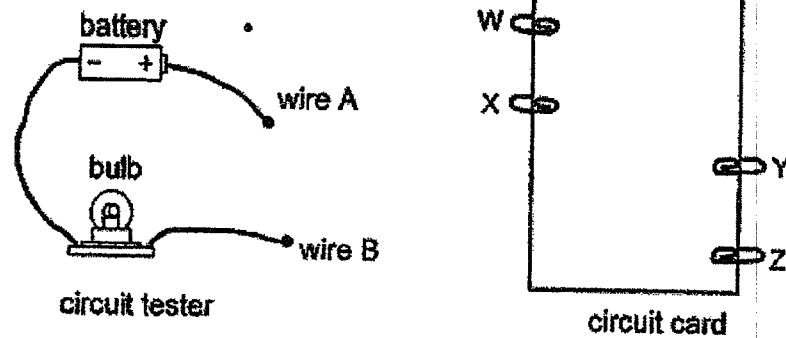

The table below shows the results when wires A and B of the circuit tester are connected to a pair of steel clips.

Steel clips	Did the bulb light up?
W and X	Yes
W and Y	No
W and Z	Yes
X and Y	No
X and Z	Yes

Which of the following is a correct connection on the underside of the circuit card that will give the results shown in the table above?

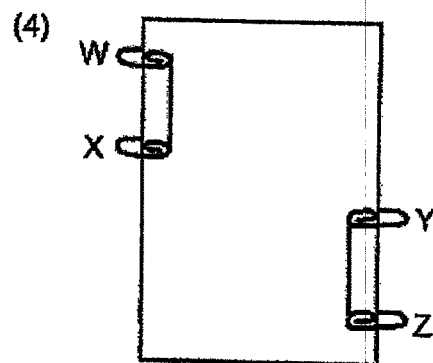
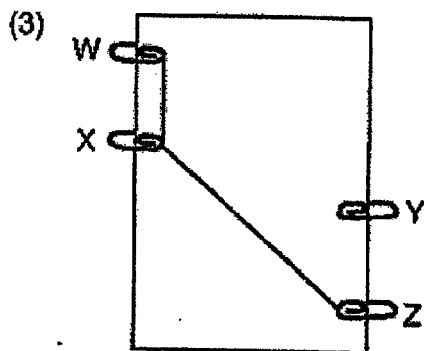
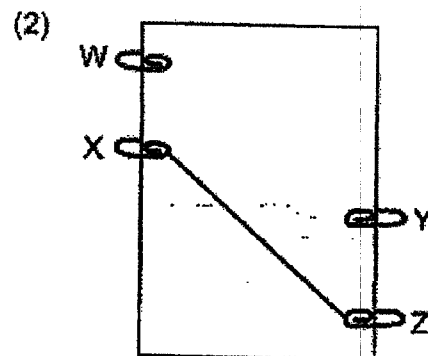
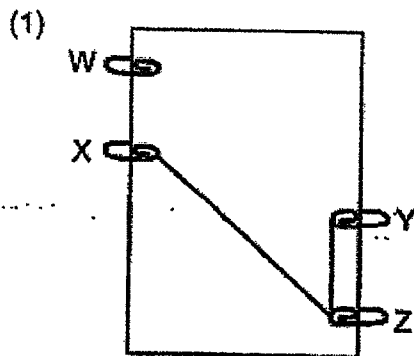

END OF BOOKLET A

Name : _____ ()

Class : Primary 5 _____

CHIJ ST NICHOLAS GIRLS' SCHOOL

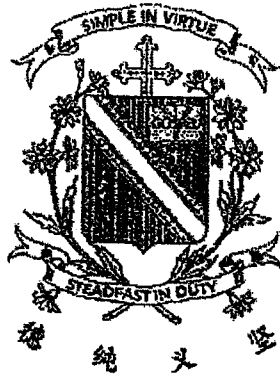

Primary 5

End Year Assessment

SCIENCE

BOOKLET B

31 October 2022

Total Time for Booklets A and B: 1 hour 45 minutes

**12 questions
44 marks**

**Do not open this booklet until you are told to do so.
Follow all instructions carefully.
Answer all questions.**

This booklet consists of 13 printed pages.

Booklet A	56
Booklet B	44
Total	100

Parent's Signature/Date

Section B (44 marks)

For questions 29 to 40, write your answers in this booklet. The number of marks available is shown in the brackets at the end of each question or part question.

29. The bar graph below shows the growth of a bean seedling over a span of 7 days.

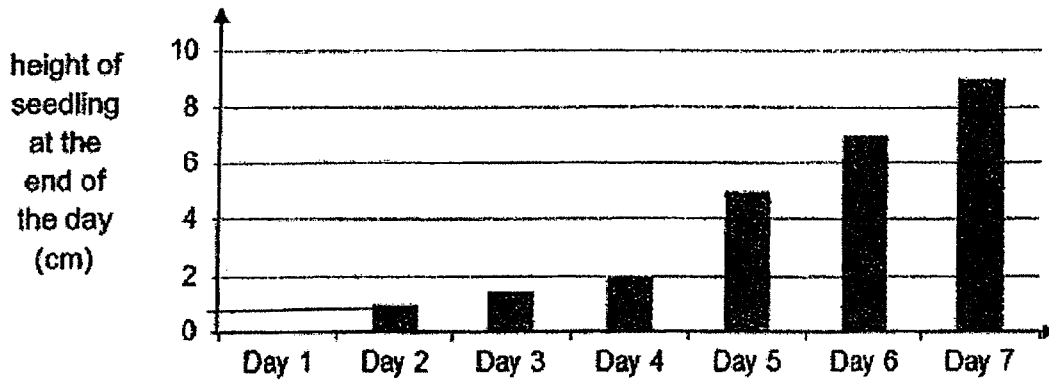

(a) How many centimetres did the seedling grow from Day 2 to Day 5? [1]

(b) On which day was the fastest growth observed? [1]

(c) State all the necessary conditions for germination of seeds to occur. [1]



30. The diagram below shows a single-celled organism which lives in a pond.

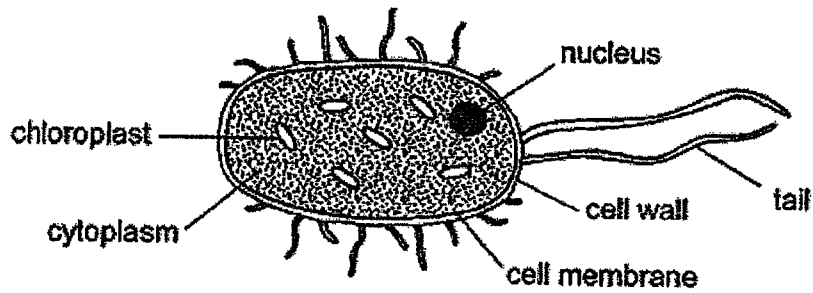

(a) Name two parts in the organism which shows that it is more likely to be a [1]
plant cell than an animal cell.

(b) This single-celled organism does not depend any other organisms for [1]
food. Why is it so?

(c) State the function of the cytoplasm. [1]



31. The diagrams below show the direction of blood flow in a fish and in a human respectively.

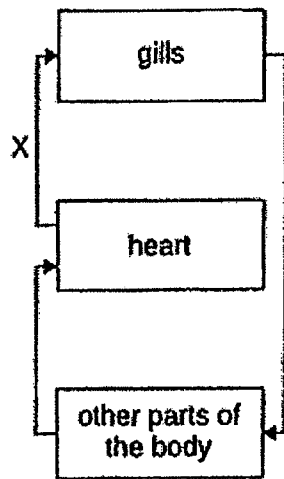

the circulatory system of a fish

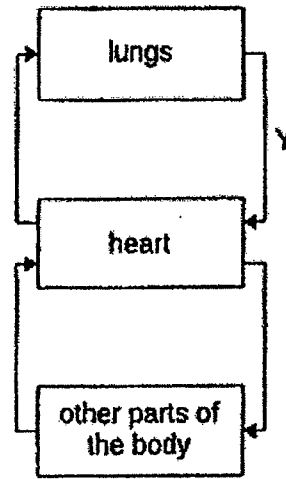

the circulatory system of a human

- (a) State the difference between the amount of oxygen and carbon dioxide found in the blood flowing in X and Y. [2]

Fish use gills to breathe in water. The diagram below shows the magnified view of the gills of a fish.

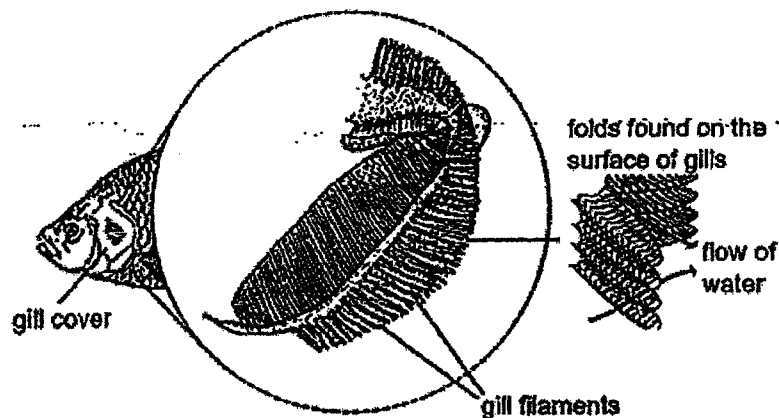

- (b) The gill filaments are folds found on the surface of the gills. Explain how the folds found on the surface of gills help the fish to survive better in water low in dissolved oxygen. [2]



32. The diagrams below show the human reproductive system and the plant reproductive system.

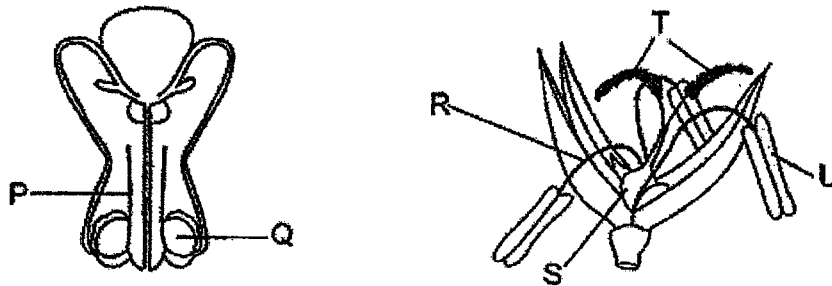

(a) Which of the following statement(s) is/are correct about human and plant reproductive systems? Put a tick (✓) in the box. [1]

	Statements	Tick (✓) if it is correct
1.	Fertilisation takes place in P and S.	
2.	The reproductive cells will travel down P and R.	
3.	The male reproductive cells are found in Q and U.	
4.	P and T has the same function in its reproduction process.	

The diagram below shows another flower with brightly coloured petals. Part Y of the flower contains yellow powdery substances and part X feels sticky when touched.



(b) Name the yellow powdery substances. [1]

(c) Based on the information above, state how the sticky substance in part X helps in the pollination of the flower. [1]



33. The diagrams below show fruits W, X, Y and Z which have been cut open.

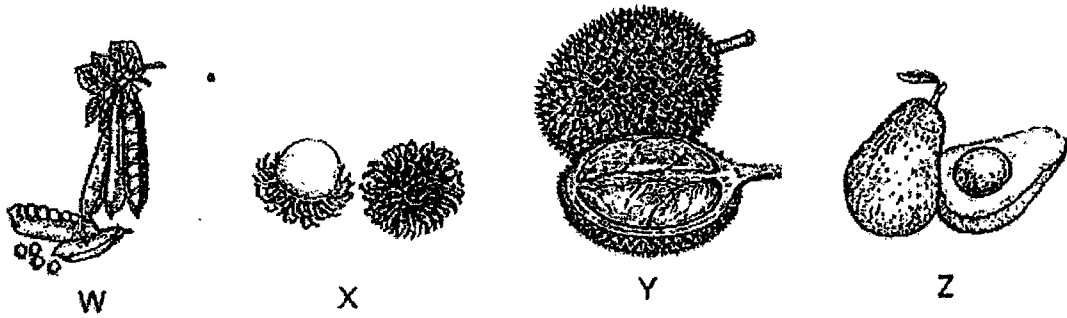

(a) Classify fruits W, X, Y and Z based on the number of ovules their flowers have in the classification chart below. [2]

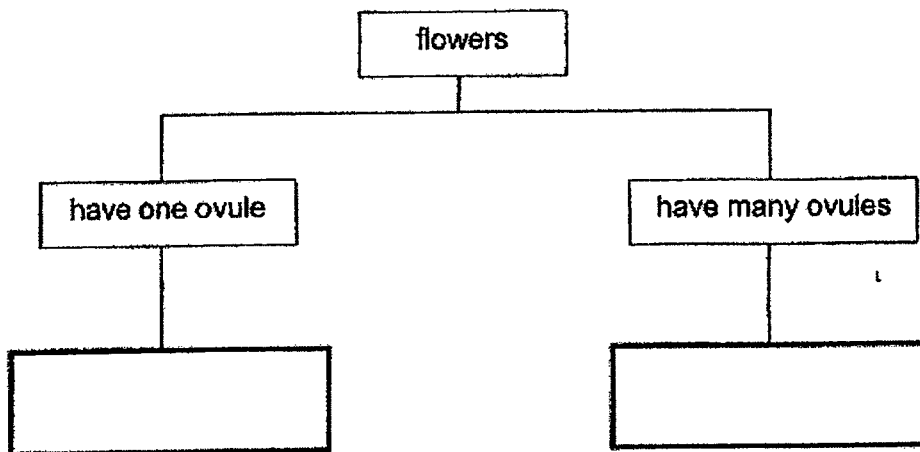

(b) State one advantage of having many ovules. [1]

(c) In the space given below, mark with 5 crosses "X" to show where the young plant of fruit W will most likely be after it is being dispersed. [1]

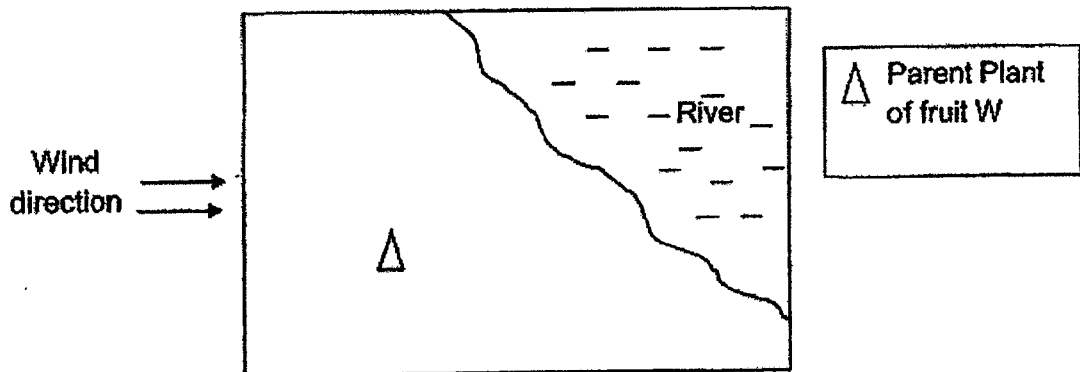

34. Two similar syringes R and S contained substances X and Y respectively. The end of each syringe was sealed. The plunger of syringe R could not be pushed in while the plunger of syringe S could.

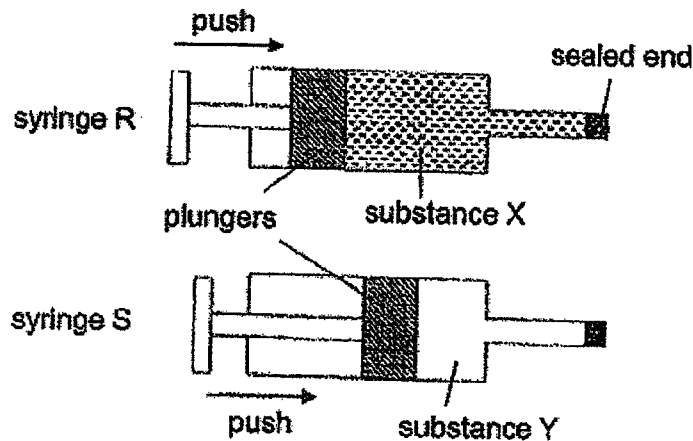

- (a) What is the likely state of matter of substance Y? [1]

- (b) Explain your answer in (a). [1]

- (c) The diagram below shows a communicating vessel. Peter poured 500 ml of water into the vessel and drew the water level in part A as shown. Draw a line to show the water level in part B and part C of the vessel. [1]

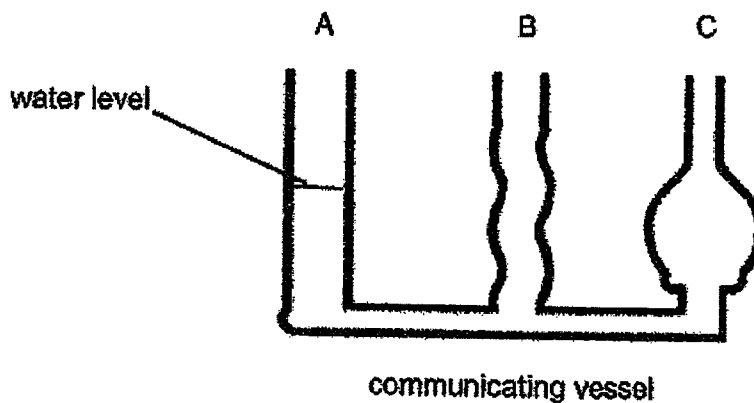

35. Ah Seng had 4 cut-outs made of different materials as shown below. The diagrams are drawn to scale.

cut-out with a star-shaped hole

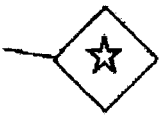

cut-out A

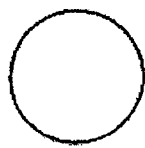

cut-out B

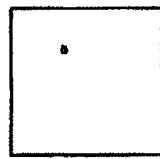

cut-out C

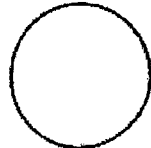

cut-out D

He placed the four cut-outs in front of a torch as shown in the diagram below.

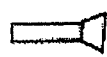

torch



A B C D

Ah Seng turned on the torch and recorded his observation on cut-out C as shown below.



bright star-shaped light on cut-out C

(a) Based on Ah Seng's observation, state whether materials A and B are transparent, translucent, or opaque. [2]

Cut-out	Transparency of material
A	
B	

(b) Based on the results of his experiment, can he find out the transparency of material D? Explain your answer. [1]

(c) What property of light enables the star-shaped light to be seen on cut-out C? [1]

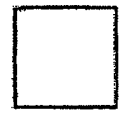

36. Lily had two similar sheets X and Y made of the same material. She placed the sheets on a heater as shown below.

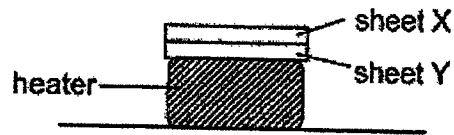

At the start, sheets X and Y were of the same length. After a while, sheet Y became longer than sheet X.

- (a) Explain why sheet Y became longer than sheet X after a while. [2]

- (b) Lily had a glass with thick walls as shown.

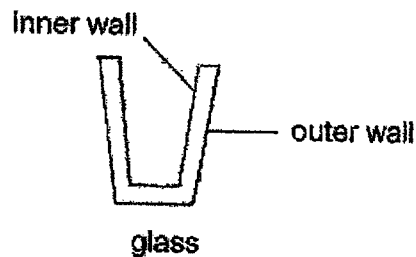

- When she poured some boiling water quickly into the glass, the glass cracked. Explain why. [2]

- (c) Give an example of a poor conductor of heat that is often used to make the handles of cooking utensils. [1]

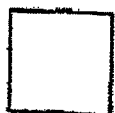

37. In the set-up below, the bar magnet is **repelled** by the electromagnet. A pointer attached to the spring moves upwards towards the support when the circuit is closed.

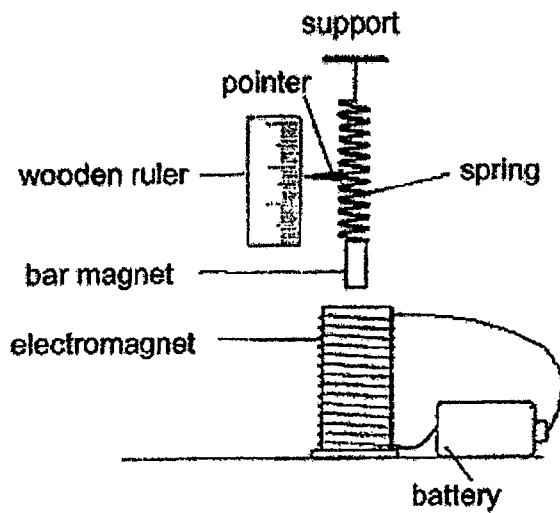

One other electrical component was added to the set-up. It was observed that the pointer moves a further distance away from the electromagnet.

- (a) State the electrical component that was added. [1]

- (b) Explain your answer in (a) above. [2]

- (c) The diagram below shows the stroke method of magnetising an iron bar. Label the poles of the iron bar when it is magnetised. [1]

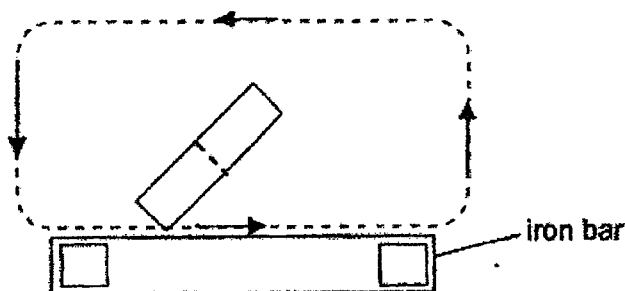

38. Jordan conducted an experiment to measure the amount of water absorbed by four strips of different materials A, B, C and D. The four strips were of the same size and thickness. He dipped them into a container of water for ten minutes as shown below. The shaded part of the strips shows the absorption of water by the four strips of materials.

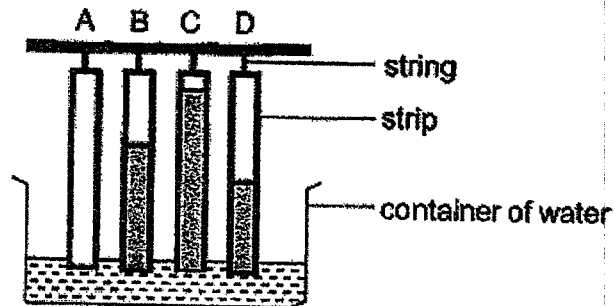

- (a) Why must the strips of material be of the same size and thickness? [1]

- (b) Based on the results above, state a property of material A [1]

- (c) Jordan's teacher suggested that he should change the water in his experiment to coloured water. State a reason for this suggestion. [1]



39. The diagram below shows the layout of a flat with its simplified electrical circuit. There is a light bulb and a switch in each room. All the circuit components are working.

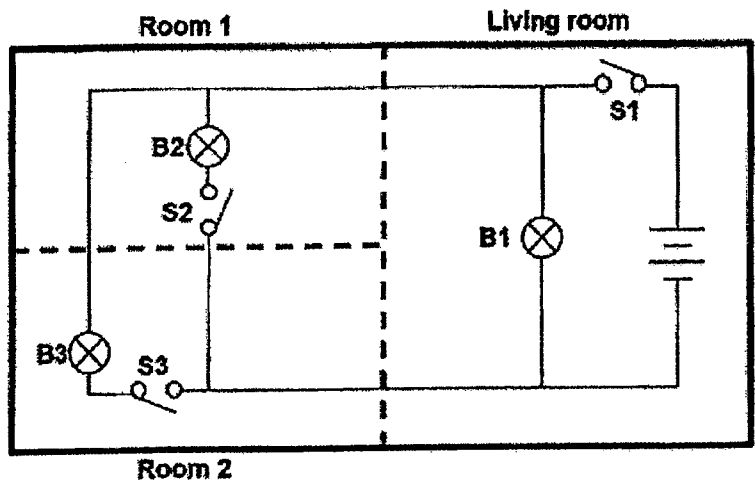

(a) Based on the diagram above, identify one disadvantage of such a circuit system. [1]

Another bulb is added to the living room to further brighten the room.

(b) Complete the circuit below by adding this additional light bulb in the living room such that: [2]

- All the bulbs will light up of equal brightness all switches
- S1 will operate the bulbs in the living room only.

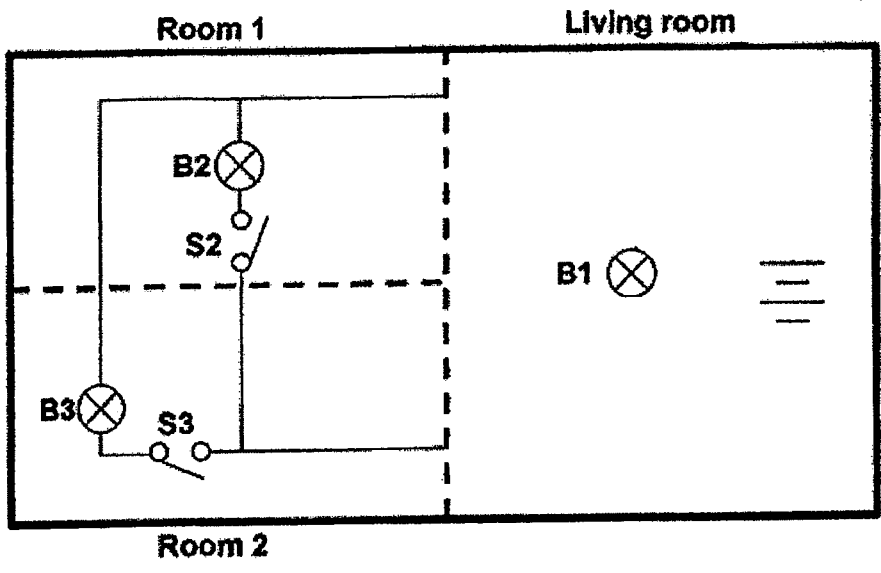

40. (a) What is evaporation?

[1]

The diagram below shows a car with its glass windows fogged up.

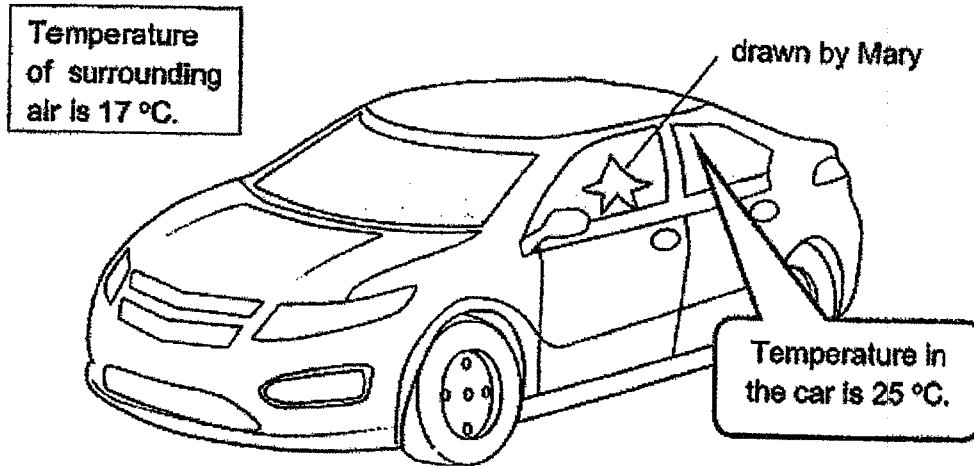

(b) Mary drew a star on one of the windows of the car as shown above. Was Mary in the car or outside the car when she drew the star?

[1]

(c) Explain your answer in (b).

[2]

(d) The car was then parked indoors with a surrounding temperature of 30 °C. Will the 'star' remain on the window, or will it disappear? Explain why.

[1]

END OF PAPER



SCHOOL : CHIJ PRIMARY SCHOOL
LEVEL : PRIMARY 5
SUBJECT : SCIENCE
TERM : 2022 SA2

SECTION A

Q 1	Q2	Q3	Q4	Q5	Q6	Q7	Q8	Q9	Q10
4	1	1	2	2	4	2	2	4	3
Q 11	Q12	Q13	Q14	Q15	Q16	Q17	Q18	Q19	Q20
1	4	4	1	3	3	4	2	4	3
Q 21	Q22	Q23	Q24	Q25	Q26	Q27	Q28		
3	4	1	2	2	1	1	3		

NAME: _____ () CLASS: P5 DATE: _____

INSTRUCTIONS: Please fill in this sheet using **GREEN INK** only.

Qn No.	CORRECTION(S)																
29	(a)	4 cm															
	(b)	Day 5															
	(c)	Water, oxygen and warmth															
30	(a)	cell wall and chloroplast															
	(b)	The single-celled organisms has chloroplast which contains chorophyll to trap light so that chloroplast of the organisms can make its own food.															
	(c)	To allow the cell substances to move within the cell.															
31	(a)	Blood flowing in X had more oxygen (and lesser oxygen) than in Y. Blood flowing in Y had more oxygen (and lesser carbon dioxide) than in X.															
	(b)	The folds will increase the surface area in contact with the water allowing the fish to absorb sufficient / enough dissolved oxygen.															
32	(a)	<table border="1"> <thead> <tr> <th>No.</th> <th>Statement</th> <th>Tick (✓) if correct</th> </tr> </thead> <tbody> <tr> <td>1</td> <td>Fertilisation takes place S.</td> <td></td> </tr> <tr> <td>2</td> <td>The reproductive cells will down P and R.</td> <td></td> </tr> <tr> <td>3</td> <td>The male reproductive cells are found in Q and U.</td> <td>✓</td> </tr> <tr> <td>4</td> <td>P and T have the same function in its reproduction process.</td> <td></td> </tr> </tbody> </table>	No.	Statement	Tick (✓) if correct	1	Fertilisation takes place S.		2	The reproductive cells will down P and R.		3	The male reproductive cells are found in Q and U.	✓	4	P and T have the same function in its reproduction process.	
		No.	Statement	Tick (✓) if correct													
		1	Fertilisation takes place S.														
		2	The reproductive cells will down P and R.														
	3	The male reproductive cells are found in Q and U.	✓														
4	P and T have the same function in its reproduction process.																
(b)	Pollen grains																
(c)	Pollen grains can be stuck onto the stigma more easily.																
33	(a)	<table border="1"> <tr> <td>Have one ovule: X and Z</td> <td>Have many ovules: W and Y</td> </tr> </table>	Have one ovule: X and Z	Have many ovules: W and Y													
	Have one ovule: X and Z	Have many ovules: W and Y															
	(b)	So that the flower can develop more seeds/ more seeds germinating and have a higher chance for the plant to reproduce and develop into adult plants, so as to have a higher chance of pollination.															
(c)																	
34	(a)	Gas (1)															
	(b)	Y can be compressed and only gas can be compressed. Thus Y is a gas.															
	(c)																

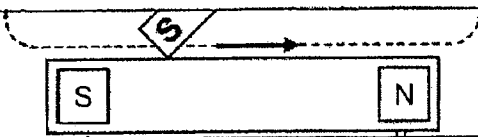
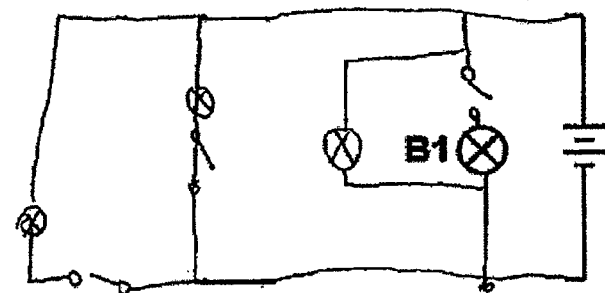
QN NO.		CORRECTION(S)	
		Cut-out	Transparency
35	(a)	A	
		B	transparent
	(b)	No, as C is opaque such that the shadow can be formed on C, so no light will reach D.	
	(c)	Required Property of Light: Light travels in a straight line	
36	(a)	Y was in direct / closer contact with the heater, so Y gained heat faster from the heater than X. Thus, Y expanded more than X.	
	(b)	The inner wall was in direct / closer contact with the boiling water, so the inner wall gained heat faster from the boiling water and expanded faster than the outer wall.	
	(c)	Plastic / Rubber / Wood	
37	(a)	A battery	
	(b)	When two batteries are used, the magnetism for the electromagnet will be greater so the electromagnet will repel the bar magnet more with a greater force of repulsion.	
	(c)		
38	(a)	To ensure that the surface area of the strip in contact with the water is the same and there will only be one changed variable which is the material of the strip.	
	(b)	A is waterproof	
	(c)	So that it will be easier for him to see the watermark.	
39	(a)	When S1 is opened, none of the bulbs in the house can light up.	
	(b)	<p>Complete the part of the circuit for the living room:</p> 	
40	(a)	Evaporation is the process in which liquids gain heat from a heat source and changes into gas form.	
	(b)	In the car	
	(c)	The temperature of air in the car is warmer than air outside the car. So the warmer water vapour in the car touches the cooler inner glass window, lose heat and condenses to form water vapour on the inner part of the window.	
	(d)	The star will disappear. There is no cooler surface for condensation to occur. So the water droplets on the window will start to gain heat from the warmer air outside the car and evaporate to form water droplets thus the star disappear.	

END OF PAPER